

PRODUCT CARD

ORDER CODE	MTIC060HV5
PRODUCT WEIGHT (Kg)	~339

TRANSFORMER

STOCK CODE	1012900650
TRANSFORMER POWER	60 kVA
INPUT - OUTPUT TYPE	Y - Y
POWER FACTOR	PF 0,8
INPUT VOLTAGE	220 VAC Ph+N / 380 VAC Ph+Ph
OUTPUT VOLTAGE	220 VAC Ph+N / 380 VAC Ph+Ph
SIZE(mm)(WxHxD)	596 x 470 x 216
FREQUENCY	50Hz
WIRE TYPE	ALUMINIUM
WEIGHT (Kg)	~294

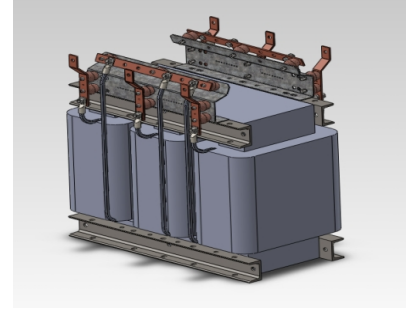

CHASSIS

CHASSIS CODE	MKGT0009-FMP-R1
SIZE(mm)(WxHxD)	800 x 800 x 647
MECHANICAL PROTECTION CLASS	IP20
WEIGHT (Kg)	~45

